

TUBE 40



Round suspended luminaire with lens optics. Top quality COB LED module with colour consistency MacAdams ≤ 3 , extensive portfolio of lumen ranges, CCTs and spectra. Variety of drivers: standard EVG on/off, DALI and wireless controlled as MasterConnect or Casambi on request. Remote, wireless occupancy & daylight sensor available to allow significant energy savings and wireless connectivity. Mounting on any type of ceiling. Body is made of aluminium tube. Standard colour RAL 9003S, any other colour from basic RAL range available at no extra cost. Variety of lengths, optics, lumen outputs and drivers allows to use this luminaire in different types of lighting projects.

Luminous flux & Luminaire Power tolerance up to 10%. System power consumption depends on components used. Luminous efficacy depends on type of LED's, electronics, optics and diffusor. The most up to date technical parameters can be found on our website and in database of LDT files.

Lighting direction:



PDF datasheet:



TUBE 40

Mounting:	Suspended
Body material:	Aluminium tube
Colour:	Standard white RAL 9003S, other RAL colours on request
Lumen output:	Standard up to 800 lm, any other on request
LED module:	Signify (Philips), Tridonic or equivalent COB LED modules
Colour temperature:	2700/3000/4000K, other on request
Colour Rendering:	CRI>80 in standard, other on request
Driver:	EVG on-off/DALI/MC (MasterConnect)/Casambi, other on request
Wireless control:	Philips MasterConnect / Casambi, other on request
Daylight/Occupancy sensor:	Wireless MCS sensor
Emergency unit:	N/A
Operating temperature range:	0°C ... +35°C
IP Class:	IP20 in standard
Power:	220-240V 50/60Hz
Lighting direction:	Direct lighting
Light distribution:	Symmetric
Optics:	Lens
Beam angle:	All types available in our LDT file database
Warranty:	5 Years standard warranty

TUBE 40 PND suspended, light down

TUBE 40 L PND suspended, light down / long tube

All current index numbers, lumen outputs, power consumption and many other technical information are available in our 2024 pricelist. Details on wireless lighting control systems on page number 896.



Energy saving MasterConnect wireless lighting control system with daylight and movement detection technology on request.



TUBE 40 PND



TUBE 40 L PND



MCS wireless daylight & occ sensor



XCS wireless switch

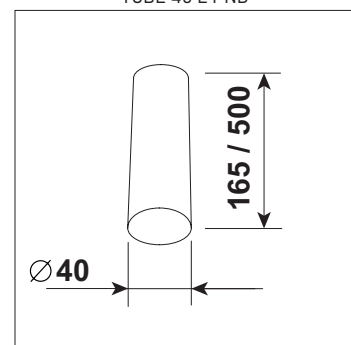

Basic dimensions